

2x

4

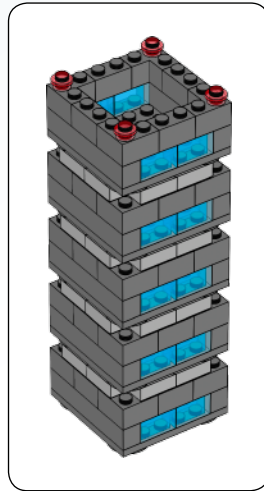

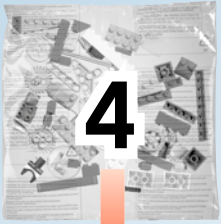
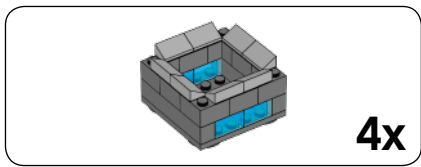

1

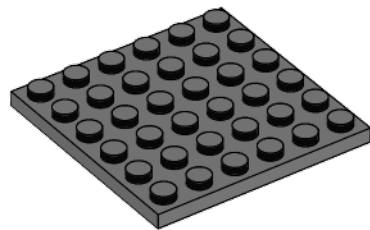

2

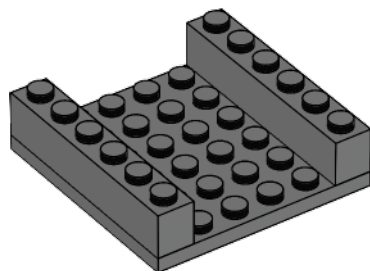



4x  
Transp. blue

3

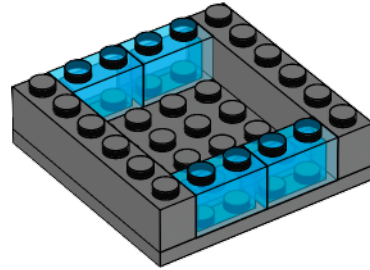

4x  
Dark grey

4

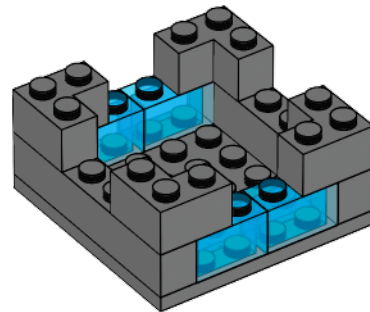



4x  
Dark grey

5

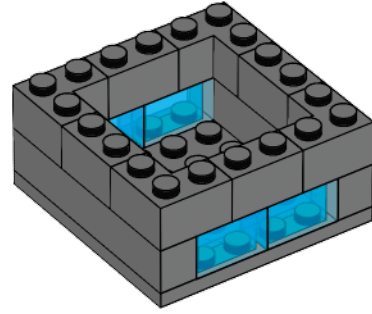

4x  
Dark grey

6

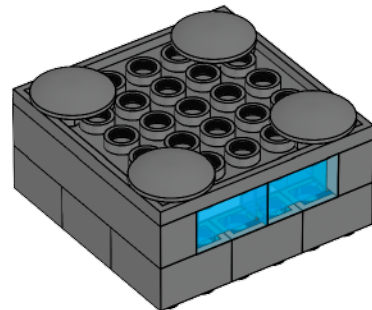
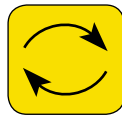

8x  
Medium grey

7

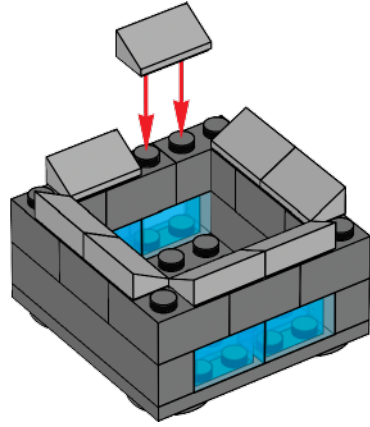

4x

8

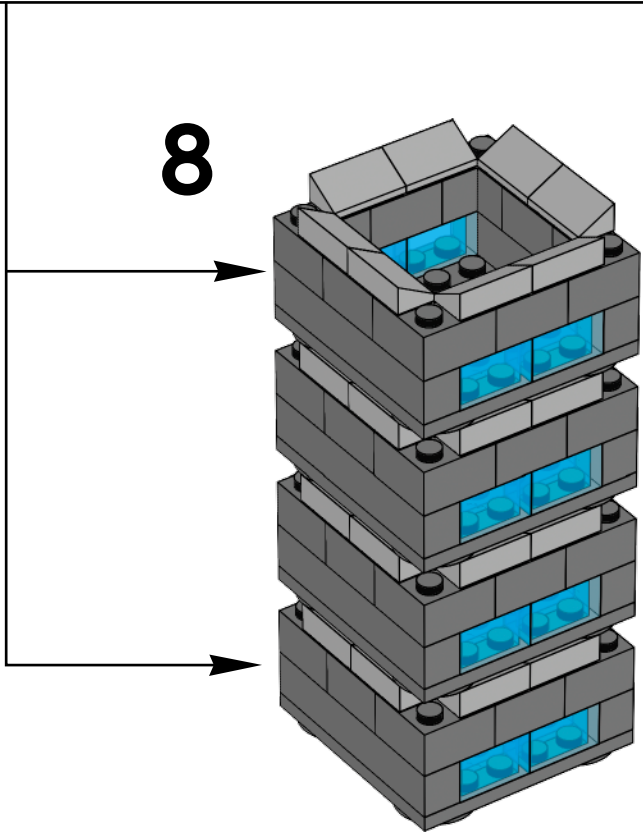

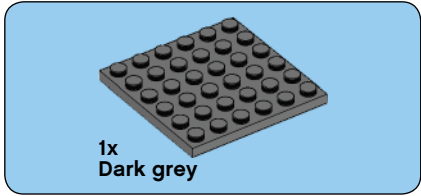
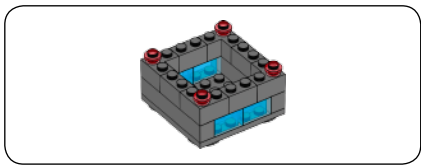

1x  
Dark grey

9

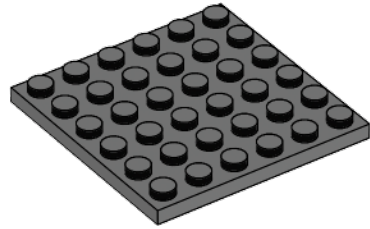

2x  
Dark grey

10

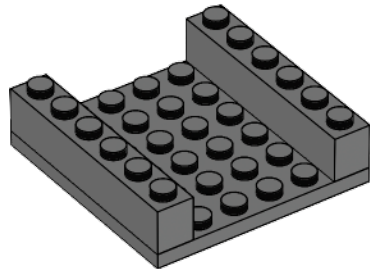



4x  
Transp. blue

# 11

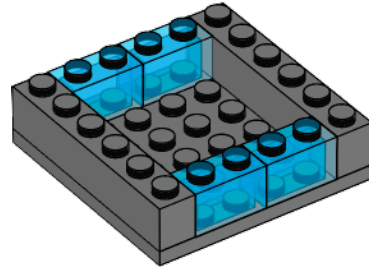

4x  
Dark grey

# 12

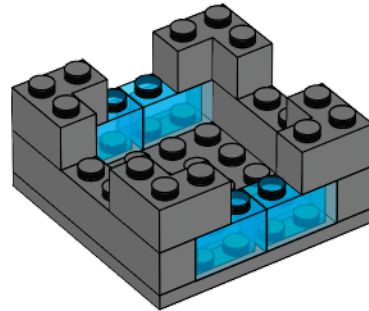



4x  
Dark grey

# 13

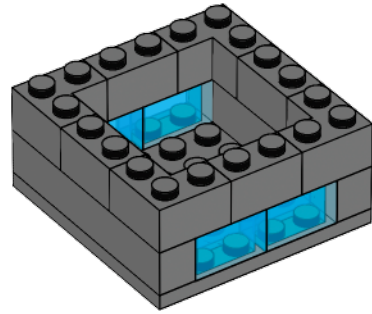

4x  
Dark grey

# 14

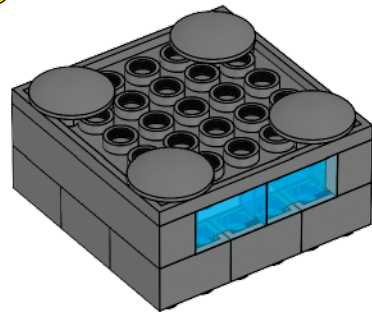



4x  
Transp. Red



15

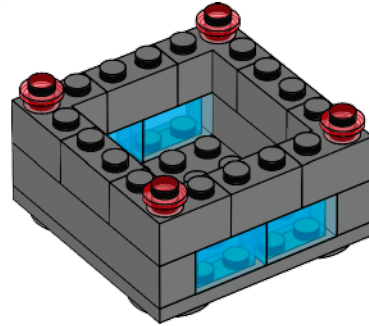

16

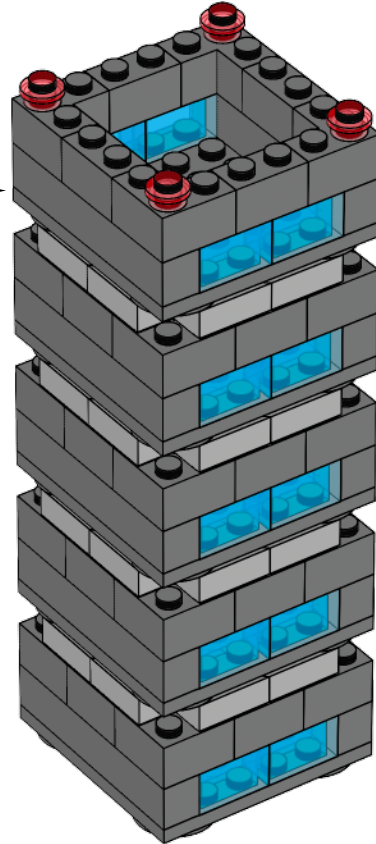

BAG 4

LEGO and the LEGO logo are trademarks of the/son des marques de commerce de/son marcas registradas de LEGO Group. ©2013 The LEGO Group.

The *FIRST*® logo is a registered trademark of the/Le *FIRST*® logo est une marquee depose de/El logotipo de *FIRST*® es una marca comercial registrada U.S. Foundation For Inspiration and Recognition of Science and Technology.